

#### Hardware Connection

##### ★ NL621 / NL621E – Physical Overview

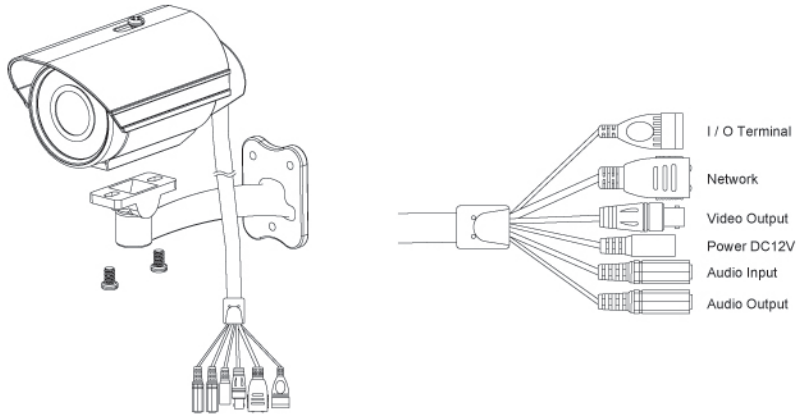

##### ★ NL621 / NL621E – Physical Connection

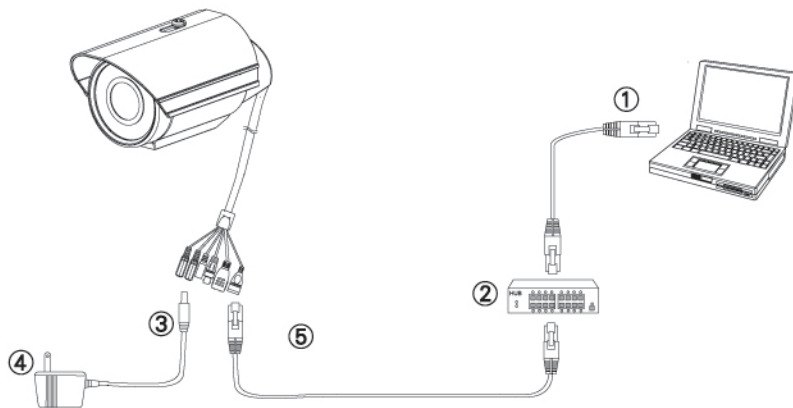

- ① Prepare a PC with Ethernet link to the network.
- ② Connect LAN port (RJ45) of the camera to a network switch/hub.
- ③ Connect power jack.
- ④ Ensure the power adaptor specification matches the power system (110V or 220V) and connect the adaptor to the outlet.
- ⑤ Check LED status (Power/Network).

#### Software Installation

The following software is necessary for the proper display and use of the camera/video server from the Web site. The software will be taken from the Software Package CD.

##### IP Installer

The IP Installer is used to locate and configure network cameras and video servers in the LAN.

#### Network Configuration

##### ★ Using IP Installer to Assign IP Address

1. Once IP Installer has been successfully installed on the PC, double click to run the software.
2. Click the menu bar [Tool] > [Search Network Device] to search the device in the LAN.
3. Select device with the MAC Address corresponds to the camera that is to be configured.

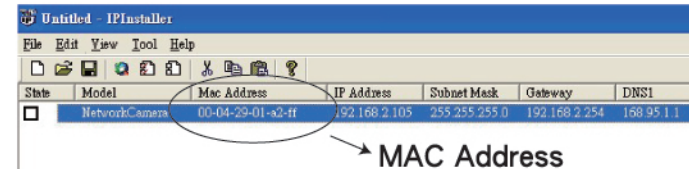
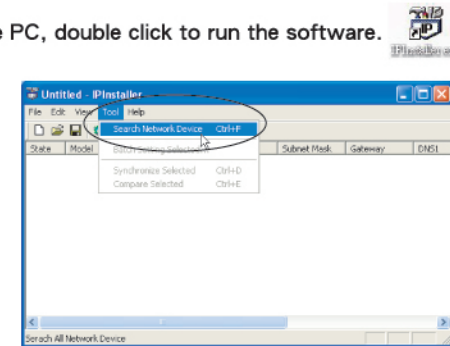

4. Double click the item to open the Property Page or click the menu bar [View] > [Property].

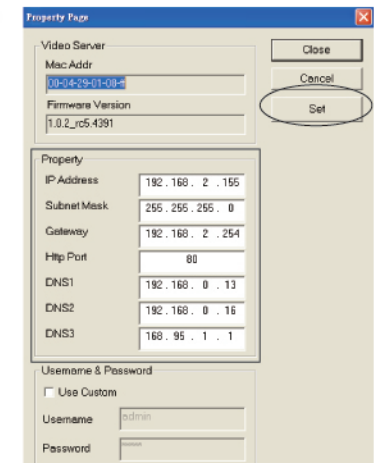

5. After filling in the properties, click [Set] button to complete the configuration settings then click [Close] button to save in the PC.

★ Open the Web-based UI

1. To access the Web-based UI of the selected unit, run the [View] > [Open Web] on the menu bar.

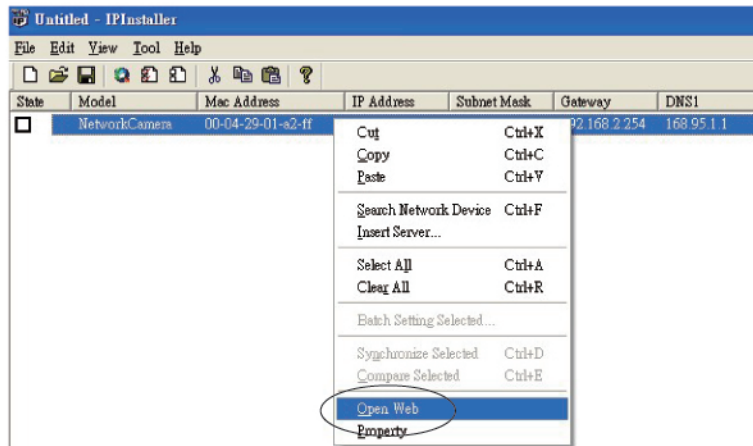

2. For first time user, there will be a prompt to install the ActiveX control.  
Confirm the installation as it is required to view the video stream and some operations.

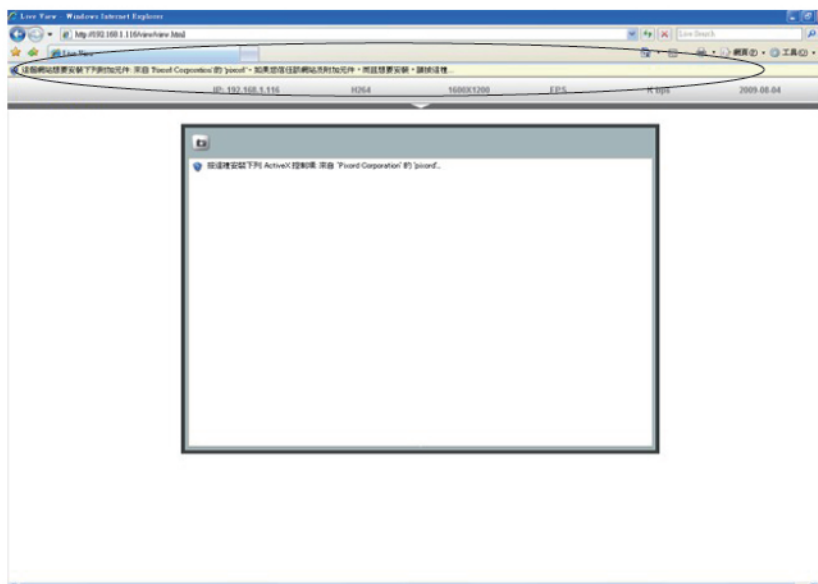

3. If the device has been configured correctly, the default Web browser will open to the home page of the selected device.



( Username and password is required. Default is admin/admin. )

★ Verify and Complete the Installation from Your Browser

If not able to get the ActiveX download properly, user must temporarily lower your security settings to perform a one-time-only installation of the ActiveX component onto your workstation, as described below:

1. From the Tools menu, select [Internet Options] > [Security] > [Custom Level]
2. Set the security level to Low and click [OK].
3. Restore the security level after the ActiveX installation.